

Article number: 2310309465ESD

Description: E+G Antistatic base for levelling elements
LV.A-100-14-AS-M10x98-ESD-C

Measures

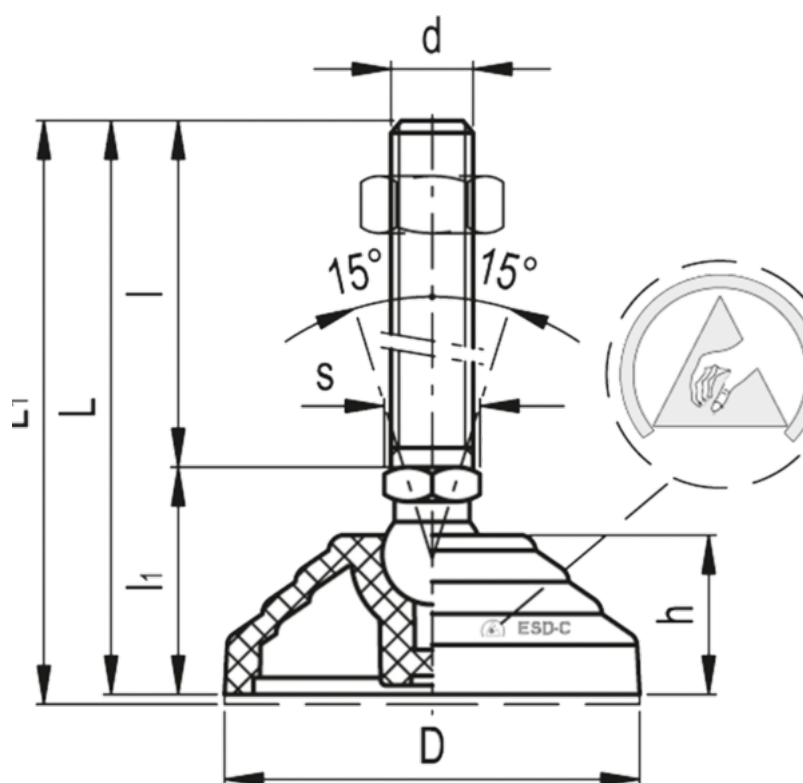

Articulation = 14	Max load = 18000
D = 100	s = 14
d = M10	Weight in (g) = 181
h = 24	
l = 98	
l1 = 33	
L = 131	
L1 = 134	